



TX9889HDN

Canala gestione cavi verticale per T7plus
Cable management for T7plus

48U

09 | 04 | 2019 | A15504

Pag. 1 / 3

Dimensions:
mm



Tecnosteel s.r.l. - Brunello - Codice Modulo: PRG.01-9 - Rev.0 - 2007/11/21

Questo disegno è proprietà intellettuale di Tecnosteel; secondo le leggi vigenti non può essere copiato, riprodotto o mostrato.
This drawing is the intellectual property of Tecnosteel; according to the laws in force it cannot be copied, reproduced or shown.

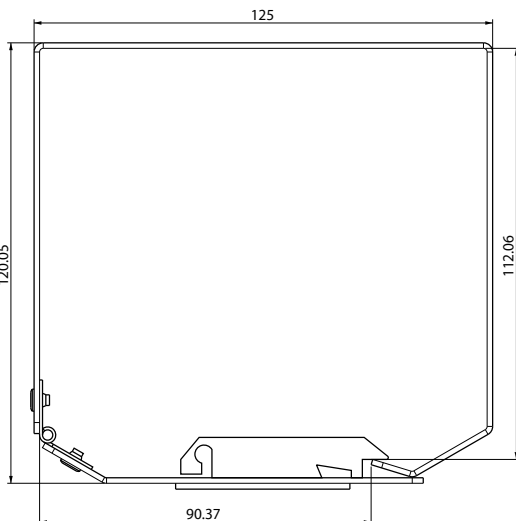
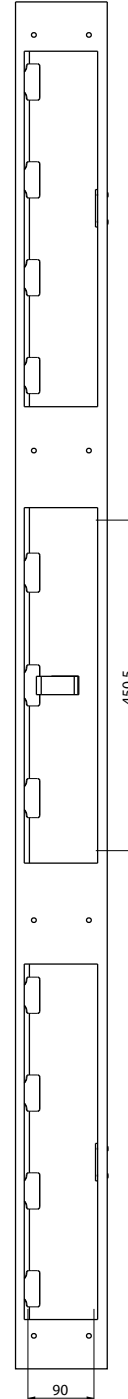
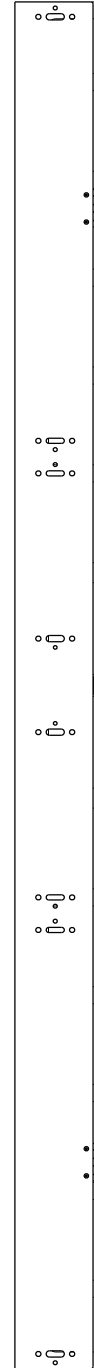
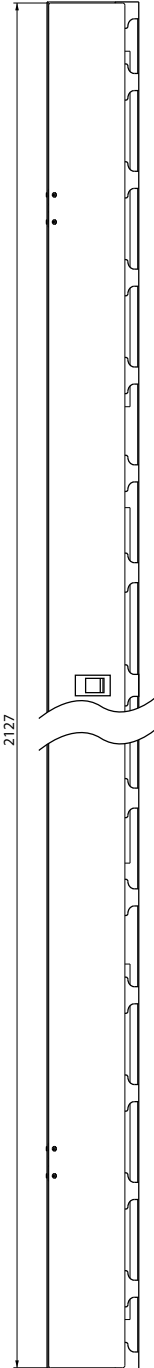
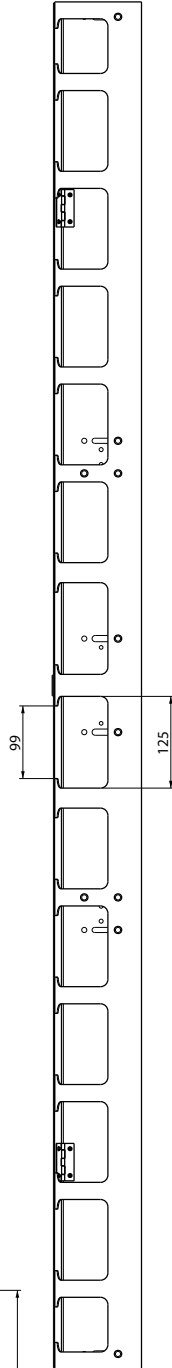
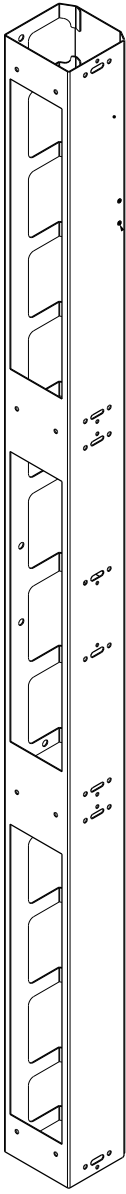
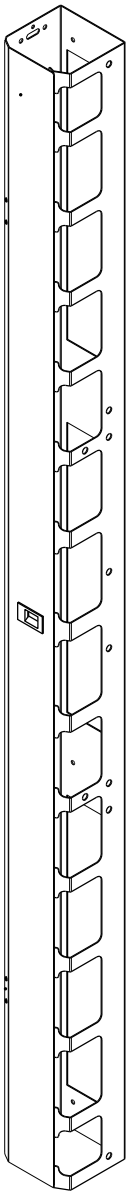

Specifiche TX9889HDN

Descrizione	Coppia canale gestione cavi verticale, completa di sportello con chiusura a scatto - 48U - Nero
Struttura	Lamiera di acciaio spessore 1,35 mm
Sportello	Lamiera di acciaio spessore 1 mm con chiusura a scatto
Montaggio	Solo nei rack T7plus - larghezza 800mm - sui montanti
Altre caratteristiche	I tre passaggi cavi posteriori permettono l'utilizzo totale dei 3 slot 19" verticali dei montanti

TX9889HDN Specifications

Description	Pair of vertical cable management complete with cover and snap-lock system - 48U
Chassis	Made of steel sheet 1,35 mm thick
19" uprights	Made of steel sheet 1 mm thick with snap closure
Mounting mode	In T7plus racks 800 mm width - on 19" uprights
Other characteristics	The three cable entries allow the full use of three vertical 19" slots of uprights

