



F9292 - F9292N

Ripiano fisso per armadi con profondità minima 400mm
 Fix shelf for standing cabinets with minimum depth 400mm
 Plateau fixe pour baies avec profondeur 400mm.

L/W 482 mm • P/D 200 mm • H 44 mm • 19" 1U

Dimensions: mm



16 | 10 | 2012

Pag. 1 / 1

Tecnosteel s.r.l. - Brunello Codice Modulo: PRG.01-9 - Rev.0 - 2007/11/21

Questo disegno è proprietà intellettuale di Tecnosteel; secondo le leggi vigenti non può essere copiato, riprodotto o mostrato.
 This drawing is the intellectual property of Tecnosteel; according to the laws in force it cannot be copied, reproduced or shown.

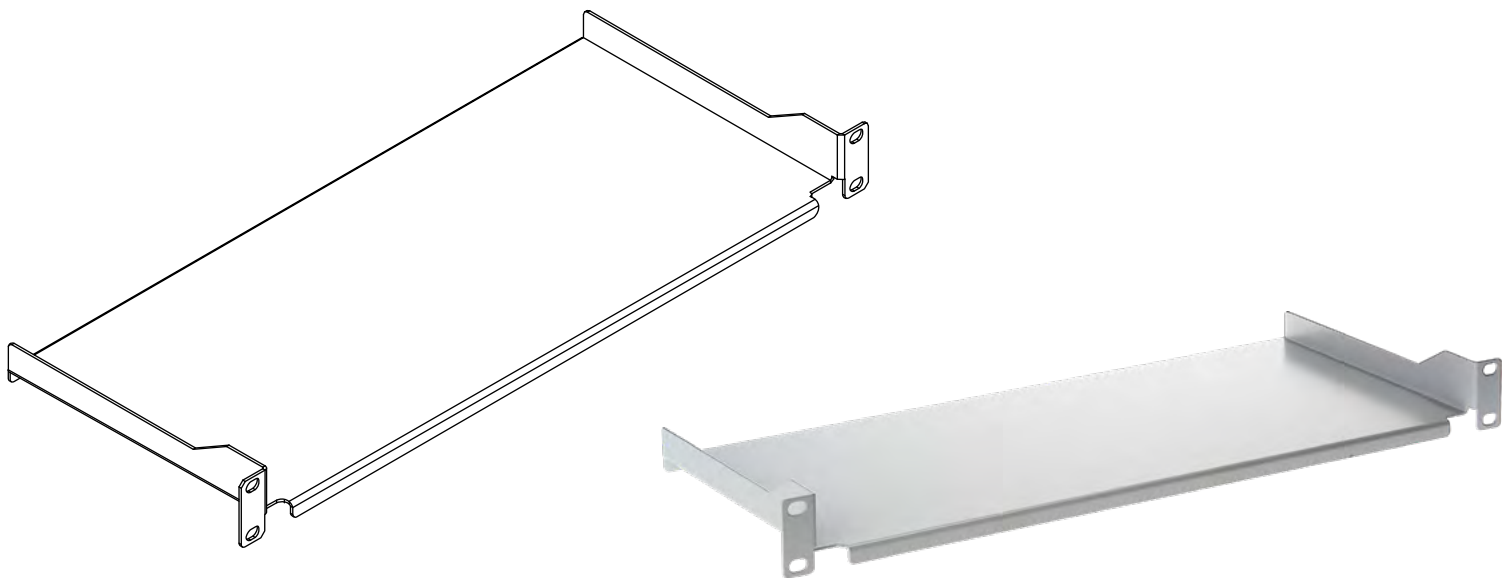
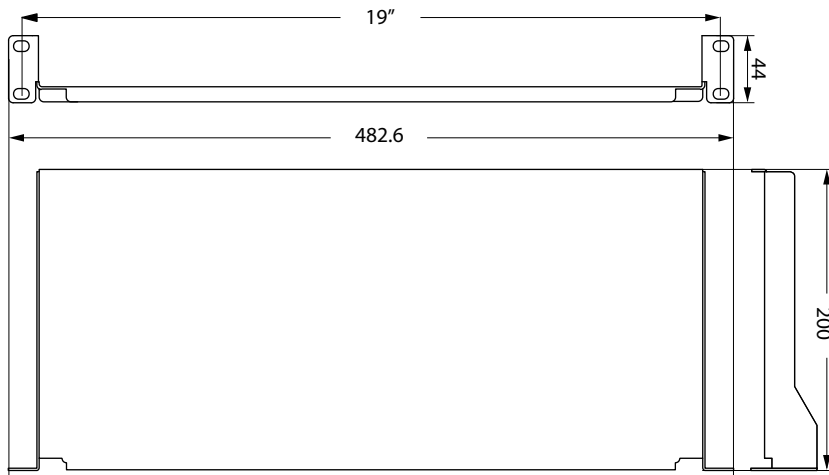

Specifiche F9292 - F9292N

Struttura	In lamiera di acciaio spessore 1,8 mm
Montaggio	Su 2 montanti 19"
Portata	15 kg
Colori	F9292 Grigio Standard F9292N Nero

F9292 - F9292N Specifications

Structure	1.8 mm steel
Mounting mode	On 2 19" uprights
Load capacity	15 kg
Colours	F9292 Standard grey F9292N Black

F9292 - F9292N Description

Structure	Tôle d'acier de 1,8 mm d'épaisseur
Méthode de montage	Sur 2 montants 19"
Capacité de charge	15 kg
Couleurs	F9292 Gris F9292N Noir